



Z100-DP-W2

15 [381] DIAMETER MAIN ROOF DRAIN W/ TOP-SET®
DECK PLATE AND 2 [51] HIGH INTERNAL WATER DAM

SPECIFICATION SHEET

TAG _____

Dimensional Data (inches and [mm]) are Subject to Manufacturing Tolerances and Change Without Notice

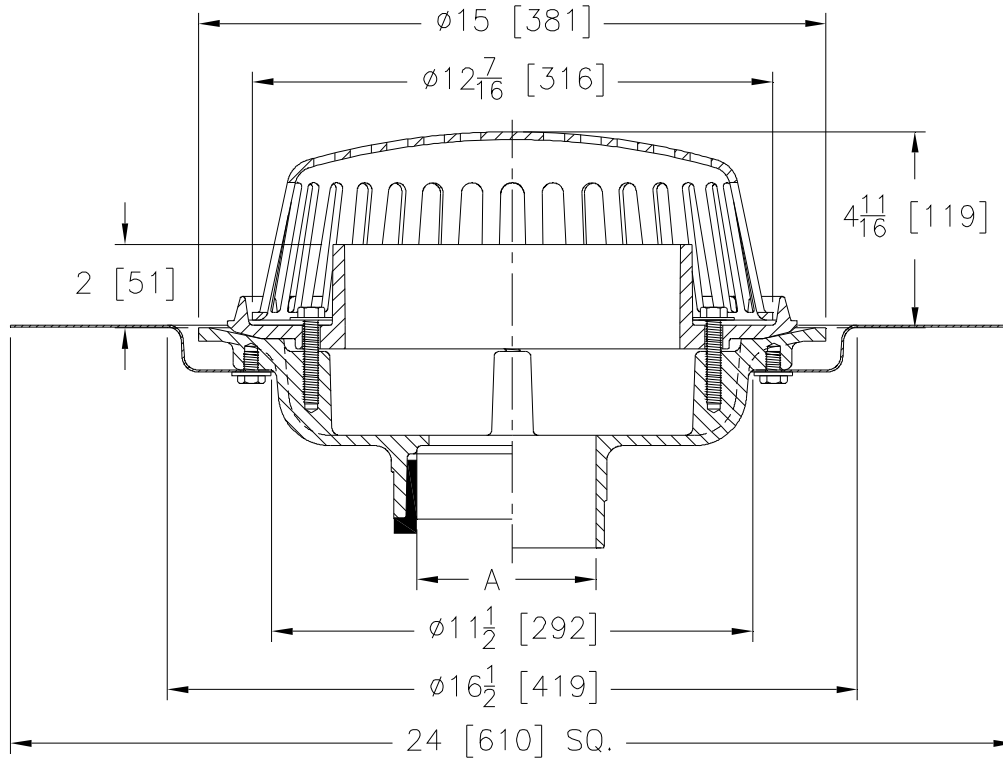

A Pipe Size in [mm]	Approx Wt. lbs [kg]	Dome Open Area in ² [cm ²]
2,3,4 [51,76,102]	38 [17]	103 [665]
6 [152]	39 [18]	
8 [203]	40 [18]	

ENGINEERING SPECIFICATION: ZURN Z100-DP-W2

15" [381mm] Diameter roof drain. Dura-Coated cast iron body with Top-Set® deck plate, combination membrane flashing clamp/gravel guard, 2" [51mm] high internal water dam, and low silhouette Poly-Dome.

OPTIONS (Check/specify appropriate options)

PIPE SIZE

- 3,4,6 [76,102,152]
- 2,3,4,6, 8 [51,76,102,152,203]
- 2,3,4,6, 8 [51,76,102,152,203]
- 2,3,4 [51,76,102]
- 6 [152]

(Specify size/type) **OUTLET**

- _____ IC Inside Caulk
- _____ IP Threaded
- _____ NH No-Hub
- _____ NL Neo-Loc
- _____ NL Neo-Loc

E BODY HT. DIM.

- 5-1/4 [133]
- 3-3/4 [95]
- 5-1/4 [133]
- 4-5/8 [117]
- 5-7/16 [138]

PREFIXES

- _____ Z D.C.C.I. Body with Poly-Dome*
- _____ ZA D.C.C.I. Body with Aluminum Dome
- _____ ZC D.C.C.I. Body with Cast Iron Dome
- _____ ZRB D.C.C.I. Body With Plain Bronze Dome

SUFFIXES

- _____ -AR Acid Resistant Epoxy Coated
- _____ -E Static Extension 1 [25] thru 4 [102] (Specify Ht.)
- _____ -EA Adjustable Extension Assembly
2-1/8 [54] thru 3-1/2 [89]
- _____ -G Galvanized Cast Iron
- _____ -HD 6-3/4 [171] High Aluminum Dome
(148 sq. in. [955 cm²] open area)
- _____ -SC Secondary Clamping Collar
- _____ -SS Stainless Mesh Screen Over Dome
- _____ -ST Dome w/ Solid Top (ZA and ZC Only)
- _____ -TC Neo-Loc Test Cap Gasket
(2,3,4 [51,76,102] NL Bottom Outlet Only)
- _____ -VP Vandal Proof Secured Top
- _____ -84 Stainless Steel Perforated Gravel Guard
- _____ -90 90° Threaded Side Outlet Body

* Regularly furnished unless otherwise specified.