



Z1188-158

SPECIFICATION SHEET

SIZE 250 LARGE CAPACITY OIL INTERCEPTOR WITH INTEGRAL EXTENSION AND HEAVY-DUTY COVER

TAG _____

Dimensional Data (inches and [mm]) are Subject to Manufacturing Tolerances and Change Without Notice

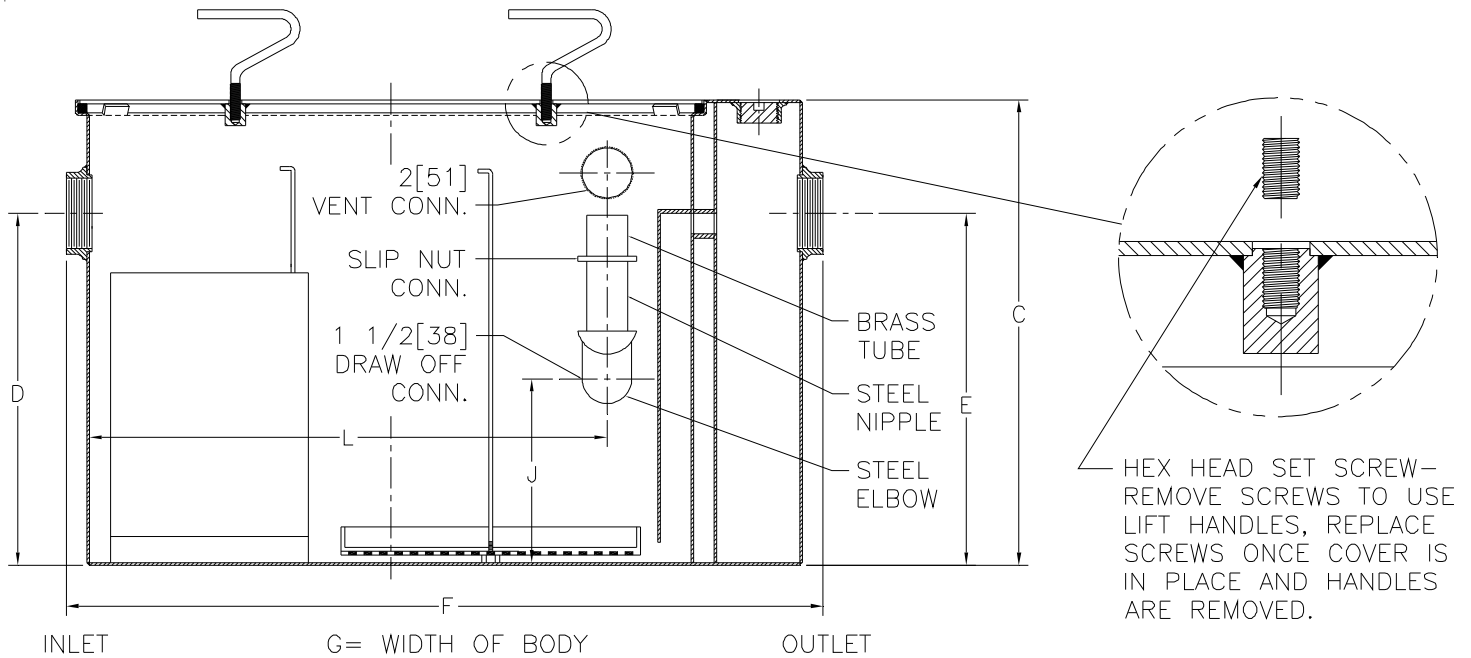

Extension Designation -E	Flow Rate G.P.M. [L/min.]	Inlet/Outlet Size	Water Capacity Gal. [L]	No. of Covers	C	D/E	F	G	J	L
E 26 3/8	250 [946]	6 [152]	460 [1741]	2	67 3/8 [1711]	36 [914]	71 [1803]	51 3/8 [1305]	23 3/8 [594]	56 5/8 [1438]

ENGINEERING SPECIFICATION: ZURN Z1188-158

Large capacity Acid Resistant Coated interior and exterior fabricated steel oil interceptor with integral extension, bronze cleanout plug and visible double wall trap seal, removable combination pressure equalizing/flow diffusing baffle and sediment bucket, horizontal baffle, adjustable oil drawoff and vent connections either side. Complete with secured, gasketed, non-skid heavy-duty traffic cover rated at 10,000 lbs. [4536 kg.] maximum safe live load with removable lift handles and flow control fitting. Regularly furnished with inlet and outlet in high position.

OPTIONS (Check/specify appropriate options)

PREFIXES

___ Z Acid Resistant Coated Fabricated Steel*

SUFFIXES

___ -K Anchor flange 1 3/4 [44] down from top and 2 [51] wide.

___ -KC Anchor flange 1 3/4 [44] down from top and 2 [51] wide with clamp collar.

*REGULARLY FURNISHED UNLESS OTHERWISE SPECIFIED

REV. DATE: 03/17/10 C.N. NO. 110847

DWG. NO. P-15857 PRODUCT NO. Z1188-158

ZURN INDUSTRIES, LLC ♦ SPECIFICATION DRAINAGE OPERATION ♦ 1801 Pittsburgh Ave. ♦ Erie, PA 16514

Phone: 814/455-0921 ♦ Fax: 814/454-7929 ♦ World Wide Web: www.zurn.com

In Canada: ZURN INDUSTRIES LIMITED ♦ 3544 Nashua Drive ♦ Mississauga, Ontario L4V1L2 ♦ Phone: 905/405-8272 Fax: 905/405-1292