



Z1732-92

HEAVY-DUTY ADJUSTABLE FLOOR DRAIN W/ 1/2 GRATE

SPECIFICATION SHEET

TAG _____

Dimensional Data (inches and [mm]) are Subject to Manufacturing Tolerances and Change Without Notice

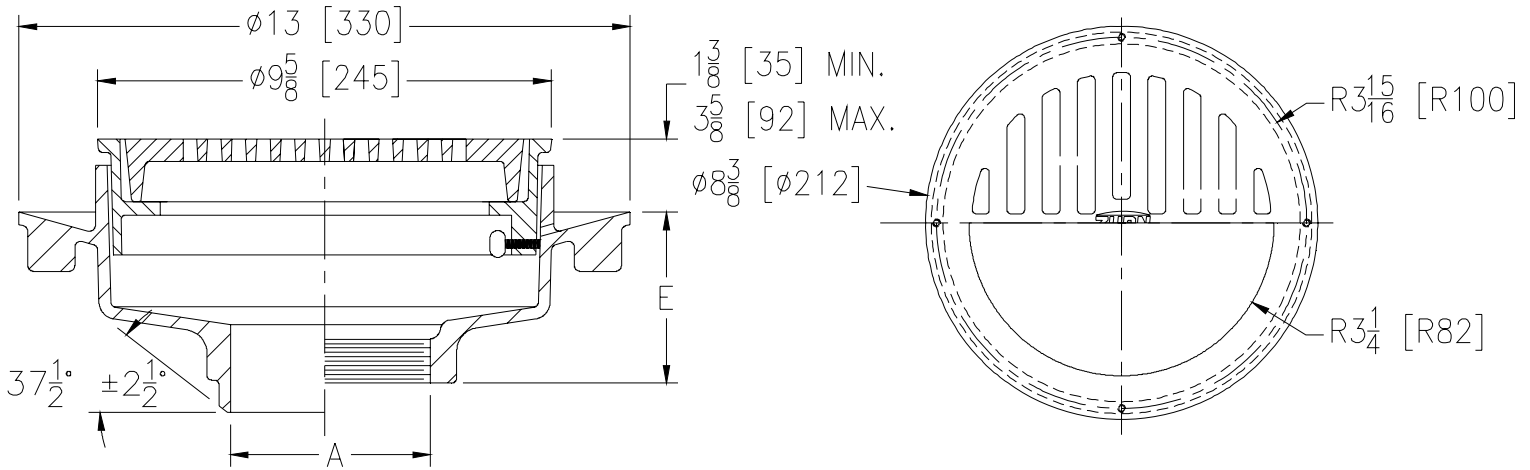

A- Pipe Size In.	Approx. Wt. Lbs. [kg]	Grate Open Area Sq. In. [cm ²]
2-3-4-6[51-76-102-152]	40 [18]	23 1/2 [152]

ENGINEERING SPECIFICATION: ZURN Z1732-92

All Type 304 (CF8) stainless steel heavy-duty adjustable floor drain with integral anchor flange, adjustable top frame and deep flange 1/2 grate with plain finish.

OPTIONS (Check/specify appropriate options)

PIPE SIZE	(Specify size/type) OUTLET	'E' BODY HT. DIM.
2-3-4 [51-76-102]	_____ BW Butt-weld (Specify Schedule 10, 40 or 80)	6 [152]
6 [152]	_____ BW Butt-weld (Specify Schedule 10, 40 or 80)	6-3/8 [162]
3-4 [51-76]	_____ IC Inside Caulk	6 [152]
2-3-4 [51-76-102]	_____ NH No-Hub	6 [152]
6 [152]	_____ NH No-Hub	6-3/8 [162]
2-3-4 [51-76-102]	_____ IP Threaded	6 [152]
6 [152]	_____ IP Threaded	6-3/8 [162]

PREFIXES

- _____ Z Type 304 (CF8) Stainless Steel Body*
- _____ ZM Type 316 (CF8M) Stainless Steel Body

SUFFIXES

- _____ -E Frame Extension Over 3 5/8 [92]
- _____ -K Seepage Holes Only
- _____ -KC Clamp Collar with Seepage Holes
- _____ -P 1/2 [13] Trap Primer Connection
- _____ -SF Satin Finish Top
- _____ -TS Top Secured with Slotted Screws
- _____ -VP Vandal-Proof Secured Top
- _____ -Y Sediment Bucket
- _____ -30 Bronze Closure Plug
- _____ -31 Plastic Closure Plug
- _____ -33 Type 304 (CF8) Stainless Steel Closure Plug
- _____ -34 Bronze Closure Plug with 3/4 [19] Test Plug

*REGULARLY FURNISHED UNLESS OTHERWISE SPECIFIED

REV.	DATE: 7/28/11	C.N. NO. 121733
DWG. NO. 306900	PRODUCT NO. Z1732-92	