



Z1920-2

16 X 16 [406 X 406] A.R.C. SANI-FLOR RECEPTOR 7 [178]
SUMP DEPTH W/ 1/2 GRATE

SPECIFICATION SHEET

TAG _____

Dimensional Data (inches and [mm]) are Subject to Manufacturing Tolerances and Change Without Notice

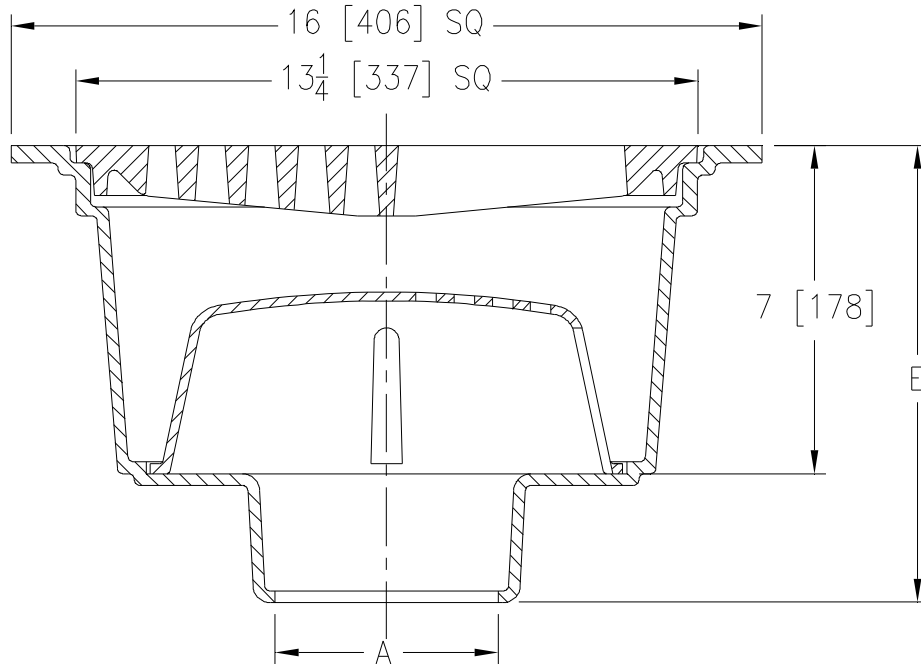

A- Pipe Size In. [mm]	Approx Wt. Lbs. [kg]	Grate Open Area Sq. In. [cm ²]
2,3,4,6,8 [51,76,102,152,203]	68 [31]	79 [509]

ENGINEERING SPECIFICATION: ZURNZ1920-2

Sani-Flor Receptor 16" x 16" x 7" [406mm x 406mm x 178mm] deep cast iron body and 1/2 square slotted grate, with white acid resisting epoxy coated interior and top, complete with aluminum anti-splash interior bottom dome strainer.

OPTIONS (Check/specify appropriate options)

PIPE SIZE

2, 3, 4, 6 [51, 76, 102, 152]
8 [203]
2, 3, 4 [51, 76, 102]

(Specify size/type) OUTLET

___ IC Inside Caulk
___ IC Inside Caulk
___ NL Neo-Loc

'E' BODY HT. DIMENSION

Z	ZN
9-3/4 [248]	10 [254]
10-1/4 [260]	10-1/2 [267]
9 [229]	9-3/16 [233]

PREFIXES

___ Z Cast Iron Body with White A.R.C. Interior*
___ ZN Cast Iron Body with White A.R.C. Interior, 16-1/2 [419] Square Nickel Bronze Frame and Full Grate

SUFFIXES

- ___ -K Anchor Flange with Seepage Holes
- ___ -KC Anchor Flange with Seepage Holes and Clamp Collar
- ___ -LD Less Internal Bottom Dome Strainer
- ___ -P 1/2 [13] Trap Primer Connection
- ___ -TC Neo-Loc Test Cap Gasket (2, 3, 4 [51, 76, 102] NL Bottom Outlet Only)
- ___ -11 Vandal-Proof Secured Grate
- ___ -23 Aluminum Bucket
- ___ -25 White A.R.C. Bucket
- ___ -31 Stainless Steel Mesh Liner for Bucket
- ___ -33 White A.R.C. Anti-Splash Bottom Dome Strainer

* Regularly furnished unless otherwise specified.