



ZS880-C90

90° STAINLESS STEEL CONNECTOR ANGLE FOR LINEAR SHOWER DRAIN

SPECIFICATION SHEET

TAG _____

Dimensional Data (inches and [mm]) are Subject to Manufacturing Tolerances and Change Without Notice

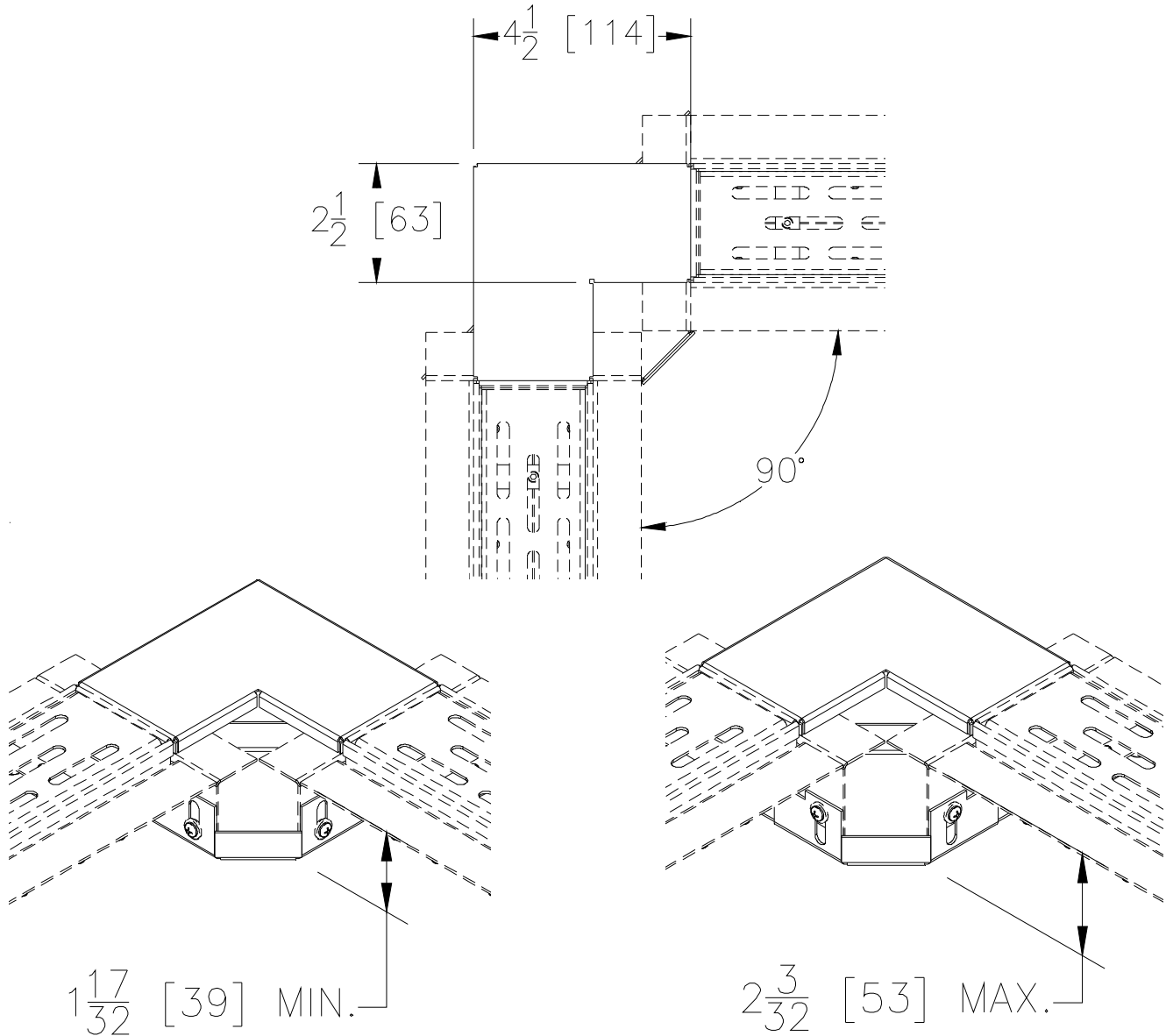

ENGINEERING SPECIFICATION: ZS880-C90

All Type 304 (CF8) Fabricated Stainless Steel, #18 Gage Connector Angle for joining of multiple ZS880 Linear Shower Drains. Two piece construction consists of a lower adjustable leg that secures two linear drain bodies together at a 90° angle, while providing floor anchoring holes and vertical adjustment of the bodies. A top cover plate attaches rigidly to the shower drain frames and provides a smooth transitioned joint with a brushed finish.

OPTIONS (Check/specify appropriate options)

PREFIXES

- ___ ZS All Type 304 (CF8) Stainless Steel*
- ___ ZR All Type 304 (CF8) Stainless Steel w/ Oil-Rubbed Bronze Finish

REV. -	DATE: 1/15/13	C.N. NO. 128684
PRODUCT NO. ZS880-C90		

*REGULARLY FURNISHED UNLESS OTHERWISE SPECIFIED